

Data sheet | Item number: 857-354

Relay module; Nominal input voltage: 24 V AC/DC; 1 changeover contact;
Limiting continuous current: 6 A; Yellow status indicator; Module width: 6 mm

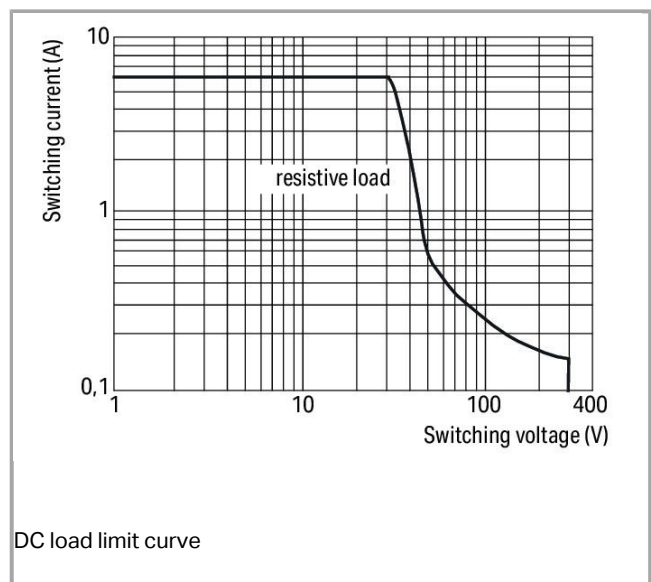

857-354

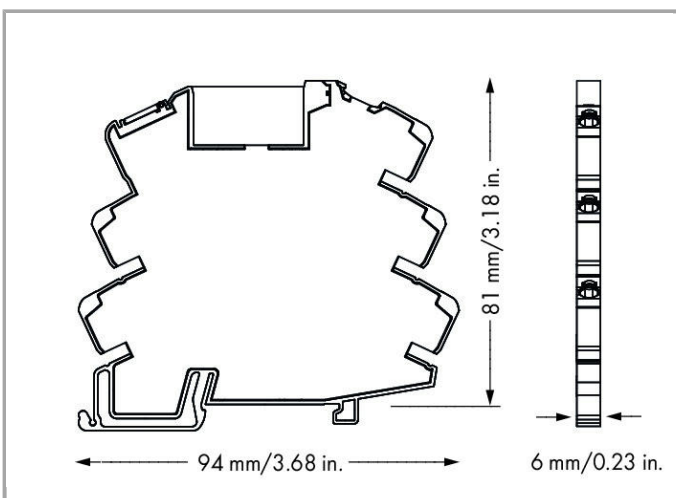
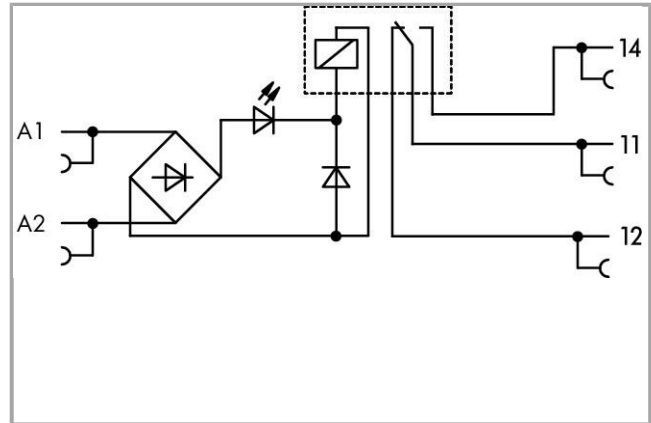
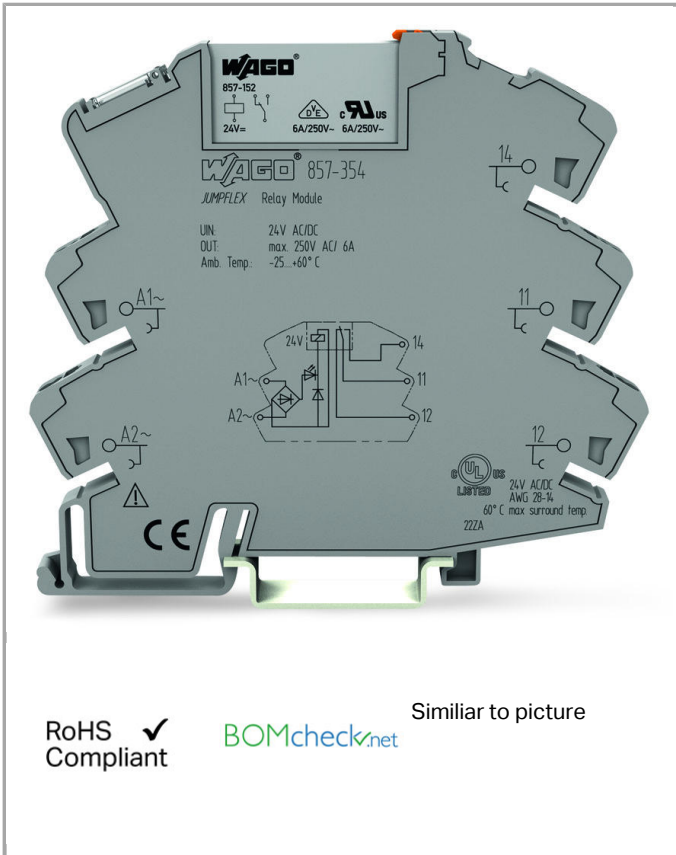

Item description

Note:

Inductive loads have to be attenuated by an appropriate protective circuit in order to protect relay coils and contacts.

Data
Technical Data

Control circuit

Nominal input voltage U_N	AC/DC 24 V
Input voltage range	-15 ... +20 %
Nominal input current at U_N	8.5 mA

Load circuit:

Number of changeover/switchover contacts	1
Contact material (relay)	AgSnO ₂
Limiting continuous current	6 A
Max. make current (resistive)	(AC) 20 A / 0.02 s
Max. switching voltage	AC 250 V
Max. switching power (resistive)	AC 1,500 VA; DC see load limit curve
Switching capacity	AC-15: 3 A / AC 250 V; DC-13: 2 A / DC 24 V
Recommended minimum load	10 V / 10 mA; 24 V / 1 mA
Min. switching current	0 μ A
Pull-in time (typ.)	15 ms
Drop-out time (typ.)	25 ms
Bounce time (typ.)	3.5 ms
Drop-out time	$\leq 0 \mu$ s
Electrical life (N.O.; resistive load; 23 °C)	50 x 10 ³ switching operations
Mechanical life (N.O.; resistive load; 23 °C)	5 x 10 ⁶ switching operations
Max. switching load with load/without load	6 min ⁻¹ / 180 min ⁻¹

Signaling

Status indication	LED yellow
-------------------	------------

Safety and protection:

Rated voltage	250 V
Rated impulse voltage	4 kV
Pollution degree	2

Dielectric strength, control/load circuit (AC, 1 min)	4 kVrms
Dielectric strength open contact (AC, 1 min)	1 kVrms
Protection class	IP20

Connection data

Connection technology	Push-in CAGE CLAMP®
Solid conductor	0.34 ... 2.5 mm ² / 22 ... 14 AWG
Fine-stranded conductor	0.34 ... 2.5 mm ² / 22 ... 14 AWG
Strip length	9 ... 10 mm / 0.35 ... 0.39 inch

Geometrical Data

Width	6 mm / 0.236 inch
Height from upper-edge of DIN-35 rail	81 mm / 3.189 inch
Depth	94 mm / 3.701 inch

Mechanical data

Type of mounting	DIN-35 rail
------------------	-------------

Material Data

Color	gray
Fire load	0 MJ
Weight	30.85 g

Environmental Requirements

Pollution degree	2
Surrounding air (operating) temperature at U _N	-40 ... 60 °C
Surrounding air (storage) temperature	-40 ... 70 °C
Processing temperature	-25 ... +50 °C

Standards and specifications

Standards/specifications	EN 61010-2-201; EN 61810-1; EN 61373; UL 508; ATEX, IEC Ex
--------------------------	--

Elementary relay

WAGO elementary relay	857-152
-----------------------	---------



Commercial data

Product Group	6 (Interface Electronics)
Country of origin	CN

GTIN	4055143122061
Customs Tariff No.	85364900990

Approvals / Certificates

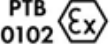
Ex-Approvals

Logo	Approval	Additional Approval Text	Certificate name
	ATEX DEKRA EXAM GmbH	EN 60079-0	BVS_14_ATEX_E_091_X
	IECEX DEKRA EXAM GmbH	IEC 60079-0	IECEX_BVS_14.0079_X
	UL UL International Germany GmbH (HAZARDOUS LOCATIONS)	ANSI/ISA 12.12.01	E198726 Sec.4

UL-Approvals



Logo	Approval	Additional Approval Text	Certificate name
	UL UL International Netherlands B.V. (ORDINARY LOCATIONS)	UL 508	E175199 Sec.4

Compatible products

















tools















	Item no.: 210-720 Operating tool with partially insulated shaft; Type 2, blade (3.5 x 0.5) mm	210-720
--	---	---------















General accessories















	Item no.: 209-184 Protection cover	209-184
	Item no.: 249-105 Group marker carrier	249-105
	Item no.: 857-152 Basic relay; Nominal input voltage: 24 VDC; 1 changeover contact; Limiting continuous current: 6 A; Module width: 5 mm; Module height: 15 mm	857-152















Marking accessories

















	Item no.: 2009-110 Marking strips; on reel; not stretchable; plain; snap-on type	2009-110
	Item no.: 2009-115 WMB-Inline; for Smart Printer; on reel; stretchable 5 - 5.2 mm; plain; snap-on type	2009-115
	Item no.: 2009-115/000-002 WMB-Inline; for Smart Printer; on reel; stretchable 5 - 5.2 mm; plain; snap-on type	2009-115 /000-002
	Item no.: 2009-115/000-006 WMB-Inline; for smartPRINTER; on reel; stretchable 5 - 5.2 mm; plain; snap-on type	2009-115 /000-006
	Item no.: 2009-115/000-007 WMB-Inline; for Smart Printer; on reel; stretchable 5 - 5.2 mm; plain; snap-on type	2009-115 /000-007
	Item no.: 2009-115/000-012 WMB-Inline; for smartPRINTER; on reel; stretchable 5 - 5.2 mm; plain; snap-on type	2009-115 /000-012
	Item no.: 2009-115/000-017 WMB-Inline; for Smart Printer; on reel; stretchable 5 - 5.2 mm; plain; snap-on type	2009-115 /000-017
	Item no.: 2009-115/000-023 WMB-Inline; for Smart Printer; on reel; stretchable 5 - 5.2 mm; plain; snap-on type	2009-115 /000-023
	Item no.: 2009-115/000-024 WMB-Inline; for smartPRINTER; on reel; stretchable 5 - 5.2 mm; plain; snap-on type	2009-115 /000-024
	Item no.: 209-128 Adaptor	209-128
	Item no.: 209-183 Marker card	209-183
	Item no.: 210-110 Fiber-tip pen	210-110
	Item no.: 793-501 WMB marking card; as card; not stretchable; plain; snap-on type	793-501
	Item no.: 793-501/000-002 WMB marking card; as card; not stretchable; plain; snap-on type	793-501 /000-002
	Item no.: 793-501/000-005 WMB marking card; as card; not stretchable; plain; snap-on type	793-501 /000-005
	Item no.: 793-501/000-006 WMB marking card; as card; not stretchable; plain; snap-on type	793-501 /000-006















	Item no.: 793-501/000-007 WMB marking card; as card; not stretchable; plain; snap-on type	/000-007	793-501
	Item no.: 793-501/000-012 WMB marking card; as card; not stretchable; plain; snap-on type	/000-012	793-501
	Item no.: 793-501/000-017 WMB marking card; as card; not stretchable; plain; snap-on type	/000-017	793-501
	Item no.: 793-501/000-023 WMB marking card; as card; not stretchable; plain; snap-on type	/000-023	793-501
	Item no.: 793-501/000-024 WMB marking card; as card; not stretchable; plain; snap-on type	/000-024	793-501
	Item no.: 793-502 WMB marking card; as card; MARKED; 1 ... 10 (10x); not stretchable; Horizontal marking; snap-on type		793-502
	Item no.: 793-502/000-002 WMB marking card; as card; MARKED; 1 ... 10 (10x); not stretchable; Horizontal marking; snap-on type	/000-002	793-502
	Item no.: 793-502/000-005 WMB marking card; as card; MARKED; 1 ... 10 (10x); not stretchable; Horizontal marking; snap-on type	/000-005	793-502
	Item no.: 793-502/000-006 WMB marking card; as card; MARKED; 1 ... 10 (10x); not stretchable; Horizontal marking; snap-on type	/000-006	793-502
	Item no.: 793-502/000-007 WMB marking card; as card; MARKED; 1 ... 10 (10x); not stretchable; Horizontal marking; snap-on type	/000-007	793-502
	Item no.: 793-502/000-012 WMB marking card; as card; MARKED; 1 ... 10 (10x); not stretchable; Horizontal marking; snap-on type	/000-012	793-502
	Item no.: 793-502/000-017 WMB marking card; as card; MARKED; 1 ... 10 (10x); not stretchable; Horizontal marking; snap-on type	/000-017	793-502
	Item no.: 793-502/000-023 WMB marking card; as card; MARKED; 1 ... 10 (10x); not stretchable; Horizontal marking; snap-on type	/000-023	793-502
	Item no.: 793-502/000-024 WMB marking card; as card; MARKED; 1 ... 10 (10x); not stretchable; Horizontal marking; snap-on type	/000-024	793-502
	Item no.: 793-503 WMB marking card; as card; MARKED; 11 ... 20 (10x); not stretchable; Horizontal marking; snap-on type		793-503













	Item no.: 793-503/000-002 WMB marking card; as card; MARKED; 11 ... 20 (10x); not stretchable; Horizontal marking; snap-on type / 000-002	793-503
	Item no.: 793-503/000-005 WMB marking card; as card; MARKED; 11 ... 20 (10x); not stretchable; Horizontal marking; snap-on type / 000-005	793-503
	Item no.: 793-503/000-006 WMB marking card; as card; MARKED; 11 ... 20 (10x); not stretchable; Horizontal marking; snap-on type / 000-006	793-503
	Item no.: 793-503/000-007 WMB marking card; as card; MARKED; 11 ... 20 (10x); not stretchable; Horizontal marking; snap-on type / 000-007	793-503
	Item no.: 793-503/000-012 WMB marking card; as card; MARKED; 11 ... 20 (10x); not stretchable; Horizontal marking; snap-on type / 000-012	793-503
	Item no.: 793-503/000-017 WMB marking card; as card; MARKED; 11 ... 20 (10x); not stretchable; Horizontal marking; snap-on type / 000-017	793-503
	Item no.: 793-503/000-023 WMB marking card; as card; MARKED; 11 ... 20 (10x); not stretchable; Horizontal marking; snap-on type / 000-023	793-503
	Item no.: 793-503/000-024 WMB marking card; as card; MARKED; 11 ... 20 (10x); not stretchable; Horizontal marking; snap-on type / 000-024	793-503
	Item no.: 793-504 WMB marking card; as card; MARKED; 21 ... 30 (10x); not stretchable; Horizontal marking; snap-on type	793-504
	Item no.: 793-504/000-002 WMB marking card; as card; MARKED; 21 ... 30 (10x); not stretchable; Horizontal marking; snap-on type / 000-002	793-504
	Item no.: 793-504/000-005 WMB marking card; as card; MARKED; 21 ... 30 (10x); not stretchable; Horizontal marking; snap-on type / 000-005	793-504
	Item no.: 793-504/000-006 WMB marking card; as card; MARKED; 21 ... 30 (10x); not stretchable; Horizontal marking; snap-on type / 000-006	793-504
	Item no.: 793-504/000-012 WMB marking card; as card; MARKED; 21 ... 30 (10x); not stretchable; Horizontal marking; snap-on type / 000-012	793-504
	Item no.: 793-504/000-017 WMB marking card; as card; MARKED; 21 ... 30 (10x); not stretchable; Horizontal marking; snap-on type / 000-017	793-504
	Item no.: 793-504/000-023 WMB marking card; as card; MARKED; 21 ... 30 (10x); not stretchable; Horizontal marking; snap-on type / 000-023	793-504

	Item no.: 793-505 WMB marking card; as card; MARKED; 31 ... 40 (10x); not stretchable; Horizontal marking; snap-on type	793-505
	Item no.: 793-505/000-005 WMB marking card; as card; MARKED; 31 ... 40 (10x); not stretchable; Horizontal marking; snap-on type /UUU-UU	793-505
	Item no.: 793-505/000-006 WMB marking card; as card; MARKED; 31 ... 40 (10x); not stretchable; Horizontal marking; snap-on type /UUU-UU	793-505
	Item no.: 793-505/000-007 WMB marking card; as card; MARKED; 31 ... 40 (10x); not stretchable; Horizontal marking; snap-on type /UUU-UU/	793-505
	Item no.: 793-505/000-012 WMB marking card; as card; MARKED; 31 ... 40 (10x); not stretchable; Horizontal marking; snap-on type /UUU-UU L	793-505
	Item no.: 793-506 WMB marking card; as card; MARKED; 41 ... 50 (10x); not stretchable; Horizontal marking; snap-on type	793-506
	Item no.: 793-506/000-005 WMB marking card; as card; MARKED; 41 ... 50 (10x); not stretchable; Horizontal marking; snap-on type /UUU-UU	793-506
	Item no.: 793-506/000-006 WMB marking card; as card; MARKED; 41 ... 50 (10x); not stretchable; Horizontal marking; snap-on type /UUU-UU	793-506
	Item no.: 793-506/000-012 WMB marking card; as card; MARKED; 41 ... 50 (10x); not stretchable; Horizontal marking; snap-on type /UUU-UU L	793-506
	Item no.: 793-506/000-017 WMB marking card; as card; MARKED; 41 ... 50 (10x); not stretchable; Horizontal marking; snap-on type /UUU-UU /	793-506
	Item no.: 793-5501 WMB marking card; as card; for terminal block width 5 - 17.5 mm; stretchable 5 - 5.2 mm; plain; snap-on type	793-5501
	Item no.: 793-5501/000-002 WMB marking card; as card; for terminal block width 5 - 17.5 mm; stretchable 5 - 5.2 mm; plain; snap-on type /UUU-UU L	793-5501
	Item no.: 793-5501/000-005 WMB marking card; as card; stretchable 5 - 5.2 mm; plain; snap-on type /UUU-UU	793-5501
	Item no.: 793-5501/000-006 WMB marking card; as card; stretchable 5 - 5.2 mm; plain; snap-on type /UUU-UU	793-5501
	Item no.: 793-5501/000-007 WMB marking card; as card; stretchable 5 - 5.2 mm; plain; snap-on type /UUU-UU/	793-5501

	Item no.: 793-5501/000-012 WMB marking card; as card; stretchable 5 - 5.2 mm; plain; snap-on type	793-5501 /000-012
	Item no.: 793-5501/000-014 WMB marking card; as card; stretchable 5 - 5.2 mm; plain; snap-on type	793-5501 /000-014
	Item no.: 793-5501/000-017 WMB marking card; as card; stretchable 5 - 5.2 mm; plain; snap-on type	793-5501 /000-017
	Item no.: 793-5501/000-023 WMB marking card; as card; stretchable 5 - 5.2 mm; plain; snap-on type	793-5501 /000-023
	Item no.: 793-5501/000-024 WMB marking card; as card; stretchable 5 - 5.2 mm; plain; snap-on type	793-5501 /000-024
	Item no.: 793-566 WMB marking card; as card; MARKED; 1 ... 50 (2x); not stretchable; Horizontal marking; snap-on type	793-566
	Item no.: 793-566/000-002 WMB marking card; as card; MARKED; 1 ... 50 (2x); not stretchable; Horizontal marking; snap-on type	793-566 /000-002
	Item no.: 793-566/000-005 WMB marking card; as card; MARKED; 1 ... 50 (2x); not stretchable; Horizontal marking; snap-on type	793-566 /000-005
	Item no.: 793-566/000-006 WMB marking card; as card; MARKED; 1 ... 50 (2x); not stretchable; Horizontal marking; snap-on type	793-566 /000-006
	Item no.: 793-566/000-007 WMB marking card; as card; MARKED; 1 ... 50 (2x); not stretchable; Horizontal marking; snap-on type	793-566 /000-007
	Item no.: 793-566/000-012 WMB marking card; as card; MARKED; 1 ... 50 (2x); not stretchable; Horizontal marking; snap-on type	793-566 /000-012
	Item no.: 793-566/000-017 WMB marking card; as card; MARKED; 1 ... 50 (2x); not stretchable; Horizontal marking; snap-on type	793-566 /000-017
	Item no.: 793-566/000-023 WMB marking card; as card; MARKED; 1 ... 50 (2x); not stretchable; Horizontal marking; snap-on type	793-566 /000-023
	Item no.: 793-566/000-024 WMB marking card; as card; MARKED; 1 ... 50 (2x); not stretchable; Horizontal marking; snap-on type	793-566 /000-024
Jumper		
	Item no.: 281-482 Comb-style jumper bar; insulated; 2-way; IN = IN terminal block	281-482

	Item no.: 859-402 Push-in type jumper bar; 2-way; Nominal current 18 A; insulated	859-402
	Item no.: 859-402/000-005 Push-in type jumper bar; 2-way; Nominal current 18 A; insulated	859-402 /000-005
	Item no.: 859-402/000-006 Push-in type jumper bar; 2-way; Nominal current 18 A; insulated	859-402 /000-006
	Item no.: 859-402/000-029 Push-in type jumper bar; 2-way; Nominal current 18 A; insulated	859-402 /000-029
	Item no.: 859-403 Push-in type jumper bar; 3-way; Nominal current 18 A; insulated	859-403
	Item no.: 859-403/000-005 Push-in type jumper bar; 3-way; Nominal current 18 A; insulated	859-403 /000-005
	Item no.: 859-403/000-006 Push-in type jumper bar; 3-way; Nominal current 18 A; insulated	859-403 /000-006
	Item no.: 859-403/000-029 Push-in type jumper bar; 3-way; Nominal current 18 A; insulated	859-403 /000-029
	Item no.: 859-404 Push-in type jumper bar; 4-way; Nominal current 18 A; insulated	859-404
	Item no.: 859-404/000-005 Push-in type jumper bar; 4-way; Nominal current 18 A; insulated	859-404 /000-005
	Item no.: 859-404/000-006 Push-in type jumper bar; 4-way; Nominal current 18 A; insulated	859-404 /000-006
	Item no.: 859-404/000-029 Push-in type jumper bar; 4-way; Nominal current 18 A; insulated	859-404 /000-029
	Item no.: 859-405 Push-in type jumper bar; 5-way; Nominal current 18 A; insulated	859-405
	Item no.: 859-405/000-005 Push-in type jumper bar; 5-way; Nominal current 18 A; insulated	859-405 /000-005
	Item no.: 859-405/000-006 Push-in type jumper bar; 5-way; Nominal current 18 A; insulated	859-405 /000-006
	Item no.: 859-405/000-029 Push-in type jumper bar; 5-way; Nominal current 18 A; insulated	859-405 /000-029

	Item no.: 859-406 Push-in type jumper bar; 6-way; Nominal current 18 A; insulated		859-406
	Item no.: 859-406/000-005 Push-in type jumper bar; 6-way; Nominal current 18 A; insulated	/000-005	859-406
	Item no.: 859-406/000-006 Push-in type jumper bar; 6-way; Nominal current 18 A; insulated	/000-006	859-406
	Item no.: 859-406/000-029 Push-in type jumper bar; 6-way; Nominal current 18 A; insulated	/000-029	859-406
	Item no.: 859-407 Push-in type jumper bar; 7-way; Nominal current 18 A; insulated		859-407
	Item no.: 859-407/000-005 Push-in type jumper bar; 7-way; Nominal current 18 A; insulated	/000-005	859-407
	Item no.: 859-407/000-006 Push-in type jumper bar; 7-way; Nominal current 18 A; insulated	/000-006	859-407
	Item no.: 859-407/000-029 Push-in type jumper bar; 7-way; Nominal current 18 A; insulated	/000-029	859-407
	Item no.: 859-408 Push-in type jumper bar; 8-way; Nominal current 18 A; insulated		859-408
	Item no.: 859-408/000-005 Push-in type jumper bar; 8-way; Nominal current 18 A; insulated	/000-005	859-408
	Item no.: 859-408/000-006 Push-in type jumper bar; 8-way; Nominal current 18 A; insulated	/000-006	859-408
	Item no.: 859-408/000-029 Push-in type jumper bar; 8-way; Nominal current 18 A; insulated	/000-029	859-408
	Item no.: 859-409 Push-in type jumper bar; 9-way; Nominal current 18 A; insulated		859-409
	Item no.: 859-409/000-005 Push-in type jumper bar; 9-way; Nominal current 18 A; insulated	/000-005	859-409
	Item no.: 859-409/000-006 Push-in type jumper bar; 9-way; Nominal current 18 A; insulated	/000-006	859-409

	Item no.: 859-409/000-029 Push-in type jumper bar; 9-way; Nominal current 18 A; insulated	859-409
		/000-029
	Item no.: 859-410 Push-in type jumper bar; 10-way; Nominal current 18 A; insulated	859-410
	Item no.: 859-410/000-005 Push-in type jumper bar; 10-way; Nominal current 18 A; insulated	859-410
		/000-005
	Item no.: 859-410/000-006 Push-in type jumper bar; 10-way; Nominal current 18 A; insulated	859-410
		/000-006
	Item no.: 859-410/000-029 Push-in type jumper bar; 10-way; Nominal current 18 A; insulated	859-410
		/000-029
transfer module		
	Item no.: 857-981 Interface adapter; 14-pole; High-side switching input	857-981
	Item no.: 857-982 Interface adapter; 14-pole; High-side switching output	857-982
	Item no.: 857-986 Interface adapter; 15-pole; High-side switching input	857-986
ferrule		
	Item no.: 216-241 Ferrule; Sleeve for 0.5 mm ² / 20 AWG; insulated; electro-tin plated; electrolytic copper; gastight crimped; acc. to DIN 46228, Part 4/09.90	216-241
	Item no.: 216-242 Ferrule; Sleeve for 0.75 mm ² / 18 AWG; insulated; electro-tin plated; electrolytic copper; gastight crimped; acc. to DIN 46228, Part 4/09.90	216-242
	Item no.: 216-243 Ferrule; Sleeve for 1 mm ² / AWG 18; insulated; electro-tin plated; electrolytic copper; gastight crimped; acc. to DIN 46228, Part 4/09.90	216-243
	Item no.: 216-244 Ferrule; Sleeve for 1.5 mm ² / AWG 16; insulated; electro-tin plated; electrolytic copper; gastight crimped; acc. to DIN 46228, Part 4/09.90	216-244

Downloads**Documentation****Bid Text**

857-354	Jan 15, 2016	doc	Download
Relaisbaustein		26.6 kB	

Instruction Leaflet

Relay Socket with pluggable small switching Relay		pdf	Download
		2.4 MB	



1 changeover contact Input nominal voltage AC/DC 24 V

Additional Information

Disposal; Electrical and electronic equipment, Packaging	V 1.0.0	pdf 265.8 kB	Download
--	---------	-----------------	----------

CAD/CAE - Smart Data

CAD data

3D Download 857-354		URL	Download
Step file 857-03xx Series	1.0 Jun 30, 2011	STP 299.3 kB	Download

Subject to changes.
